



SPECIFICATION DATA FOR STAND ALONE MV 450 MINI VENTILATOR

PennBarry Model MV450 STAND ALONE INDOOR CONVERTIBLE W/ LOW AMBIENT / ROTATION SENSOR / CLIMATE SMART

Unit Data	
CFM	360-680
Voltage	115v - 1 Phase
MCA - Stationary	14.65
OCPD - Stationary	20
Filter Size	10 x 20 x 2
Net Weight - lbs.	195
Shipping Weight - lbs.	215

Wheel Data	
Potential Volts	115v
Motor Speed -rpm	1050
Full Load Amps	0.7
Wheel Depth - in	2
Wheel Diameter - in	19.3
Construction / Media	One Piece / Polymeric

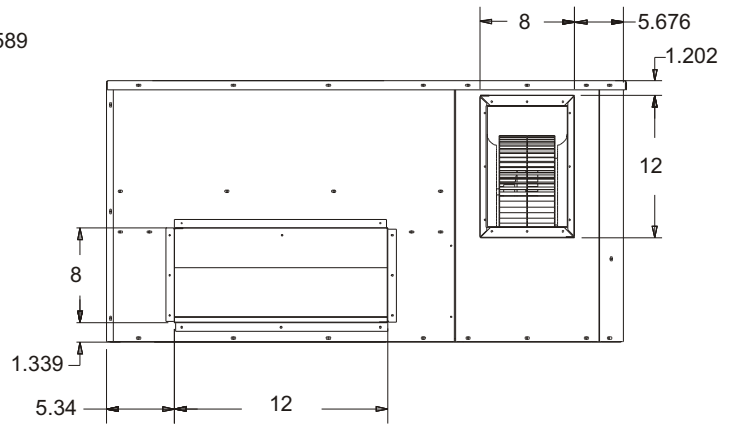
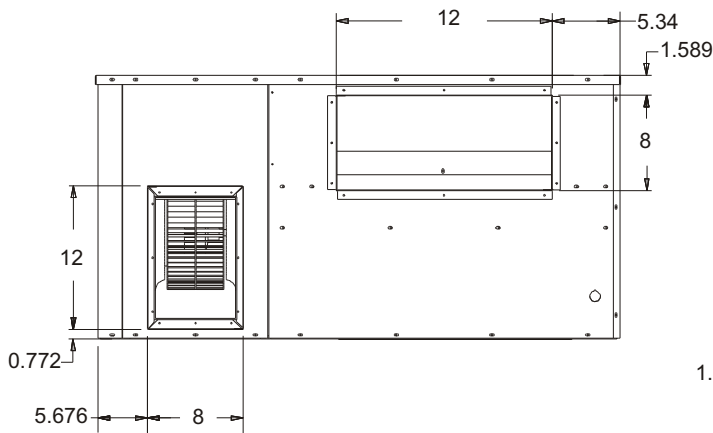
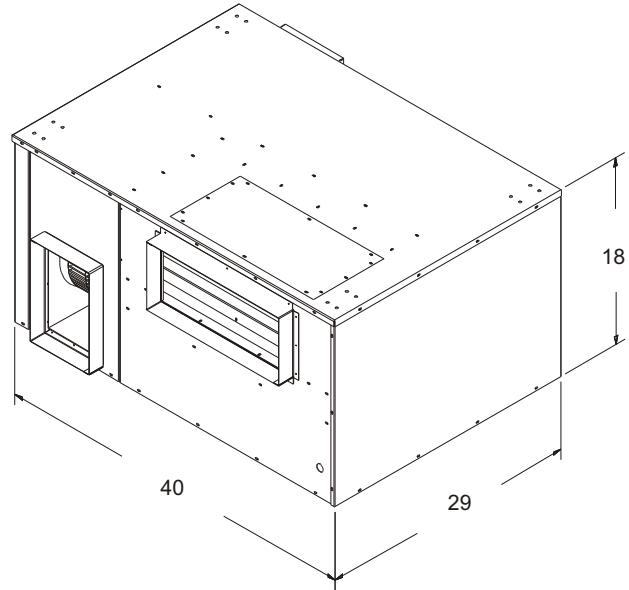

Fresh Air Blower Data	
Motor - hp	1/3
Wheel Size (dia x width) -in	DD 9 x 4AT
Motor Speed -rpm	1625
Motor Speed(s)	3
Bearing Type	Sleeve
Full Load Amps	4.0 (6.2 Max)
Service Factor	1

Exhaust Air Blower	
Motor - hp Stationary	1/3
Wheel Size (dia x width) -in	DD 9 x 4AT
Motor Speed -rpm	1625
Motor Speed(s)	3
Bearing Type	Sleeve
Full Load Amps - Stationary	4.0 (6.2 Max)
Service Factor	1

Oct 18, 2013