

UVS2, CLASS 1, ARRANGEMENT-4
 INLET BOX AND CURB CAP, OUTLET STACK

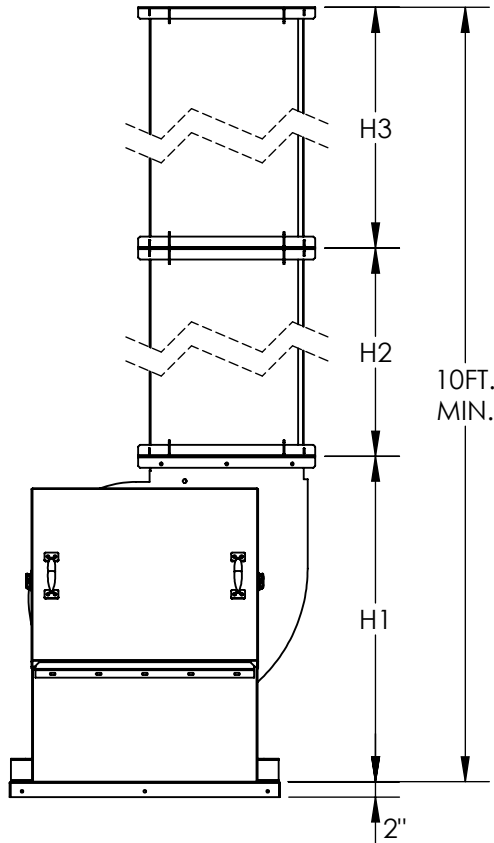

INLET VIEW

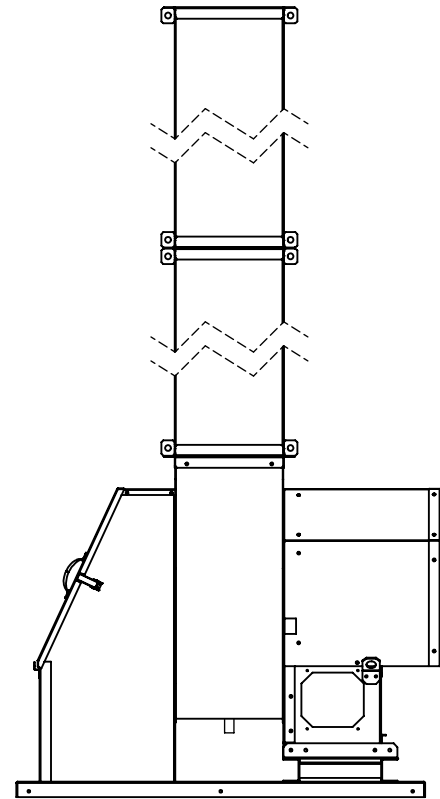

DIMENSIONAL DATA

SIZE	H1	H2	H3	J	WT. (lbs)	
					ALUMINIUM	STEEL
60	32.56	45.13	45.13	18.00	2 X 12	2 X 31
70	32.56	45.13	45.13	18.00	2 X 12	2 X 31
80	32.56	45.13	45.13	18.00	2 X 12	2 X 31
105	32.56	45.13	45.13	18.00	2 X 12	2 X 31
122	34.25	44.38	44.38	18.00	2 X 14	2 X 35
135	35.38	43.81	43.81	18.38	2 X 20	2 X 38
150	37.50	42.75	42.75	20.00	2 X 21	2 X 41
165	39.13	41.94	41.94	21.63	2 X 23	2 X 44
182	41.13	40.69	40.69	23.63	2 X 24	2 X 48
200	44.75	39.13	39.13	25.75	2 X 26	2 X 57
222	49.00	37.00	37.00	28.25	2 X 34	2 X 71
245	53.25	34.88	34.88	30.75	2 X 35	2 X 74
270	58.25	32.38	32.38	33.75	2 X 36	2 X 77

STANDARD CONSTRUCTION:

1. Aluminum construction with lifting lugs (not to lift entire fan).
2. Use of guy wires is not required when used with inlet box and curb cap.
3. Stacks will be shipped loose.

ALL DIMENSIONS ARE IN INCHES, ALL WEIGHTS ARE APPROXIMATE